

AUTOMATIC FRACTION
COLLECTOR V2 (AFC)

USER MANUAL



www.izon.com

Izon Science Limited provides this document to its customers with a product purchase to use in the product operation. This document is copyright protected and any reproduction of the whole or any part of this document is strictly prohibited, except with the written authorisation of Izon Science Limited.

The contents of this document are subject to change without notice. All technical information in this document is for reference purposes only. System configurations and specifications in this document supersede all previous information received by the purchaser.

Izon Science Limited makes no representations that this document is complete, accurate or error-free and assumes no responsibility and will not be liable for any errors, omissions, damage or loss that might result from any use of this document, even if the information in the document is followed properly.

Izon products are designed and manufactured under a quality system certified to ISO 13485:2016.

This document is not part of any sales contract between Izon Science Limited and a purchaser. This document shall in no way govern or modify any Terms and Conditions of Sale, which Terms and Conditions of Sale shall govern all conflicting information between the two documents.

Izon Science Limited
PO Box 9292
Addington
Christchurch 8024
New Zealand

Telephone: +64 3 357 4270
Email: support@izon.com
Website: www.izon.com

TABLE OF CONTENTS

1	Definitions and Writing Conventions.....	4
2	Safety and Hazards.....	6
2.1	Safe Use Requirements and Specifications.....	6
2.2	Hazards.....	6
3	Introduction to the Automatic Fraction Collector (AFC)	10
3.1	Overview.....	10
3.2	Intended Use.....	11
4	Instrument Specifications	12
4.1	Instrument Layout.....	12
5	Assembly and Setup Instructions	15
5.1	Instrument Power and General Operating Procedures	15
5.2	General Operating Procedures.....	15
5.3	Assembling and Installing the AFC	15
5.4	Aligning the Carousel.....	17
5.5	Calibrating the Scale.....	18
5.6	Adjusting Lighting Settings.....	18
6	qEV Specifications	19
7	Operating Instructions.....	20
7.1	Setting Up a Run.....	20
7.2	Choosing Run Parameters.....	21
7.3	Initiating a Run	28
7.4	Completing a Run.....	30
8	Resources	31
8.1	Repair and Servicing of the AFC.....	31
8.2	Updating the AFC Firmware.....	31
8.3	Maintenance of the AFC.....	34
8.4	Troubleshooting.....	37
9	Contact Us.....	40

1 / DEFINITIONS AND WRITING CONVENTIONS

Make sure to follow the precautionary statements presented in this guide. Safety and other special notices will appear in boxes and include the symbols detailed in [Table 1](#).

Table 1: Safety and Hazard Symbols





	This symbol indicates general advice on how to improve procedures or recommends measures to take in specific situations
	This symbol indicates where special care should be taken
	Earth (ground) terminal
	Direct Current (DC)
	Voltage polarity of the jack
SETUP	Text that appears in pink is used to indicate buttons and sequences that are used on the AFC touchscreen

Table 2: Terminology Used in this Manual

TERM	DEFINITION
AFC Firmware	The firmware that is used on the AFC instrument; the user interacts with this firmware via the instrument's touchscreen; see Section 8 .
AFC Updater	The software package that is used to update the AFC Firmware. The AFC Updater is run on a computer with Windows 10 that is connected to the AFC instrument via a USB cable; see Section 8 .
Buffer Volume (BV)	The BV is defined by the Purified Collection Volume (PCV); it is the volume that elutes before the PCV, and therefore contains very few extracellular vesicles. The BV may differ by resin type, and is collected into the central well of the AFC.
Calibration Weight	The supplied 10 g weight used to calibrate the scale; see Section 5 .
Default Buffer Volume	AFCs have a default buffer volume setting for each column, which can be adjusted to tailor the volume that is collected. Refer to the appropriate qEV column user manual for details on selecting the buffer volume that suits you.
Flush Position	The zero position of the carousel; buffer exiting the column will enter the flush hole and be emptied through the silicone waste tube.
Fraction	A quantity of a sample collected from a fractionating separation process.
Fraction Count	The number of fractions to be collected during a run; the maximum number of fractions that can be collected per run is 30.
Fraction Volume	The volume of each fraction collected during a run; there are default fraction volumes for each column type; see Section 7 .
Lighting	There are two light modules on the AFC, the "tower" which corresponds to the vertical portion of the AFC behind the qEV column mount, and the "halo" which corresponds to the horizontal ring beneath the carousel; see Section 5 .
Purified Collection Volume (PCV)	A customisable, collected volume containing purified particles of interest. The PCV can be adjusted to suit different priorities.

2 / SAFETY AND HAZARDS

2.1 Safe Use Requirements and Specifications

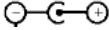
Table 3: Safe Use Requirements and Specifications

SAFE USE REQUIREMENT		SPECIFICATION
Operating Temperature	Indoor Use	Ambient temperature of 5-25 °C
Altitude		Up to 2,000 metres above sea level
Relative Humidity		20-80% relative humidity
Power Consumption		15 W
Ingress Protection		IP30
Pollution Degree Rating		Pollution Degree 2
Power Supply Unit (ATS024T- A120)	Input AC	100-240 V 1.2 A 47-63 Hz
	Output DC	12 V nom 2 A max current 24 W max power

2.2 Hazards

The AFC is a laboratory product. However, if biohazardous samples are present, adhere to current Good Laboratory Practices (cGLPs) and comply with any local guidelines specific to your laboratory and location.

Chemical Hazards



The AFC system contains no potentially hazardous chemical materials, however the qEV columns are delivered containing < 0.1% ProClin 200 or < 0.1% sodium azide*, both of which are harmful if swallowed or in contact with skin. When the appropriate qEV column is used on the AFC system, the user is potentially exposed to a dilute solution of sodium azide or ProClin 200* from the column and/or waste hose outlet.

*Izon is transitioning from the use of sodium azide to ProClin 200 for the storage of qEV columns. For information on how to identify which storage buffer is in your column, visit support.izon.com

Please review the following guidelines and precautions prior to each use of the qEV column, especially if flushing with an antimicrobial buffer before storage (recommended).

Prevention

- ▶ Do not get into eyes, on skin, or on clothing.
- ▶ Wash skin thoroughly after handling.
- ▶ Do not eat, drink, or smoke when using this product.
- ▶ Avoid release of product into the environment.
- ▶ Wear protective gloves and clothing; follow general laboratory precautions.

Response

- ▶ IF SWALLOWED: immediately call a POISON CONTROL CENTRE/Doctor.
- ▶ IF ON SKIN: gently wash with plenty of water.
- ▶ Remove immediately any contaminated clothing and wash before reuse.
- ▶ Collect any spillage and dispose of appropriately.

For more information, see the SDS Documentation for qEV columns: support.izon.com/qev-columns-safety-data-sheet-sds

Disposal of Biohazardous Material

Be sure to adhere to the following guidelines and comply with any local guidelines specific to your laboratory and location regarding use and disposal.

General Precautions

- ▶ Always wear laboratory gloves, coats, and safety glasses with side shields or goggles.
- ▶ Keep your hands away from your mouth, nose, and eyes.
- ▶ Completely protect any cut or abrasion before working with potentially infectious or hazardous material.
- ▶ Wash your hands thoroughly with soap and water after working with any potentially infectious or hazardous material before leaving the laboratory.
- ▶ Remove watches and jewellery before working at the bench.
- ▶ The use of contact lenses is not recommended due to complications that may arise during emergency eye-wash procedures.
- ▶ Before leaving the laboratory, remove protective clothing.
- ▶ Do not use a gloved hand to write, answer the telephone, turn on a light switch, or physically engage with people who are not wearing gloves.
- ▶ Change gloves frequently.
- ▶ Remove gloves immediately when they are visibly contaminated.
- ▶ Do not expose materials that cannot be properly decontaminated to potentially infectious or hazardous material.
- ▶ Upon completion of the tasks involving potentially infectious or hazardous materials, decontaminate the work area with an appropriate disinfectant or cleaning solution (1:10 dilution of household bleach is recommended).

Dispose of the following potentially contaminated materials in accordance with laboratory local, regional, and national regulations:

- ▶ Biological samples
- ▶ Reagents
- ▶ Used reaction vessels or other consumables that may be contaminated

Explosive or Flammability Hazards

The AFC poses no uncommon hazard related to flammability or explosion when used in a proper manner as specified by Izon Science Limited.

Mechanical Hazards



The carousel is capable of moving during sample collection, calibration, and when the unit returns to the home position. Please keep fingers and loose clothing clear, and refrain from removing the carousel cover when the unit is in operation.

Electrical Hazards

The AFC poses no uncommon electrical hazard to operators if installed and operated properly without physical modification and connected to a power source of proper specification.

The user is protected from hazardous voltage with power adaptor double insulation.

Touching exposed USB connection on back of unit without electrostatic discharge (ESD) precaution may lead to temporary fault. Please avoid contacting USB port unless updating unit. In the event of an ESD event that causes a temporary fault, please switch off the unit and leave for 1 minute before resuming operation.



Use only the power supply unit provided with this product. Specification of unit is detailed in [Table 3](#). Use as directed: install indoors and avoid contact between the AFC and spilled fluids.

Transport

Before moving or shipping the AFC, decontamination procedures must be performed. Always move or ship the AFC with the supplied packaging materials which will protect the instrument from damage. If appropriate containers cannot be found, contact your local Izon office. During transport, ensure the carousel cover or hexagonal cardboard packaging is placed over the scale. After transporting the AFC, calibrate the scale before use.

Storage

The AFC system can be stored under the following conditions:

- ▶ Temperature range: 0 to 60 °C
- ▶ Relative humidity: maximum 80%

Disposal

The AFC system contains electronic or electrical materials; it should be disposed of as unsorted waste and must be collected separately, according to the European Union Directive: Waste Electrical and Electronic Equipment - WEEE Directive. The user is fully responsible for ensuring that the obsolete equipment and/or consumables are recycled or disposed of in accordance with this and/or any other relevant laws and regulations in the countries where the instrument is being recycled or disposed of. Alternatively, obsolete equipment and/or consumables may be returned to your local Izon Science representative to be processed appropriately. Contact your local Izon representative for more information.

3 / INTRODUCTION TO THE AUTOMATIC FRACTION COLLECTOR (AFC)

3.1 Overview

Isolation of extracellular vesicles (EVs) using the combination of qEV size-exclusion columns and AFC increases uniformity of collected volumes, decreases experimental run-time, and eliminates many of the inaccuracies that are inherent in the manual collection of the PCV. The AFC offers users the ability to scale up EV isolation through automation of several steps, including equilibration, PCV elution, cleaning, and regeneration of the columns.

The AFC manages the collection of fractions from the column by automatically separating the buffer volume (pink area in [Figure 1](#)) and the volume of the fractions containing EVs. The buffer volume is collected in the central well of the carousel. The type of qEV column used in each run will determine the volume of liquid that is collected in the central well. Once the buffer volume has been collected, the instrument will begin collecting a predetermined number of fractions of a given volume as set by the user. The fractions after the buffer volume correspond to the PCV (blue zone in [Figure 1](#)).



The AFC measures the volume of each fraction by weight as it fills with liquid eluting from the column. When the designated threshold weight is reached, the fluid flow is automatically stopped to prevent dripping of fluid during repositioning of the carousel.

The type of qEV column used in each run will depend on the user's preferences and research applications. For more information on which column to use, see [Section 6: qEV Specifications](#) and for more information on choosing a collection schedule, see [Section 7: Choosing Run Parameters](#).

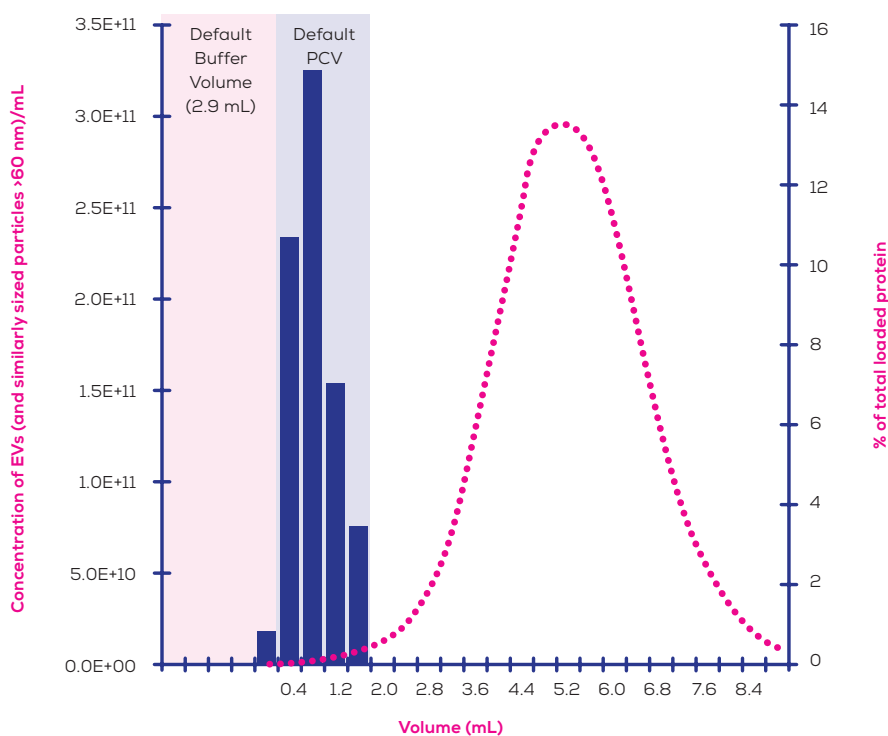

Figure 1: Typical elution profile for a qEVoriginal/35 nm Gen 2 column with 0.5 mL of human plasma loaded; proteins elute in a later volume than extracellular vesicles (EVs) and similarly sized particles >60 nm. The particle concentration was measured using an Exoid and protein levels by bicinchoninic acid (BCA) assay.

3.2 Intended Use

The AFC is used to automate the collection of EV-containing volumes from qEV columns. The instrument is intended for use by professional personnel only.

4 / INSTRUMENT SPECIFICATIONS

4.1 Instrument Layout

The following components are provided in the box.

Table 4: Components of the AFC System

1a	AFC Instrument with attached Silicone Waste Tube
1b	Scale
2	Nozzle Set (x8) - The entirety of the nozzle tip, silicone tubing, and the adaptor used to connect qEV columns
3	qEV Column Mount (x5)
4	Carousel Cover
5	Reversible Carousel
6	Carousel Plate
7	qEVoriginal Reservoir
8	5.0 mL Collection Tube (x15)
9	2.0 mL Collection Tube (x30)
10	12 Volt Power Supply
11	Power Lead
12	USB 2.0 Type A to USB 2.0 Micro Cable (male to male)
13	10 g Calibration Weight

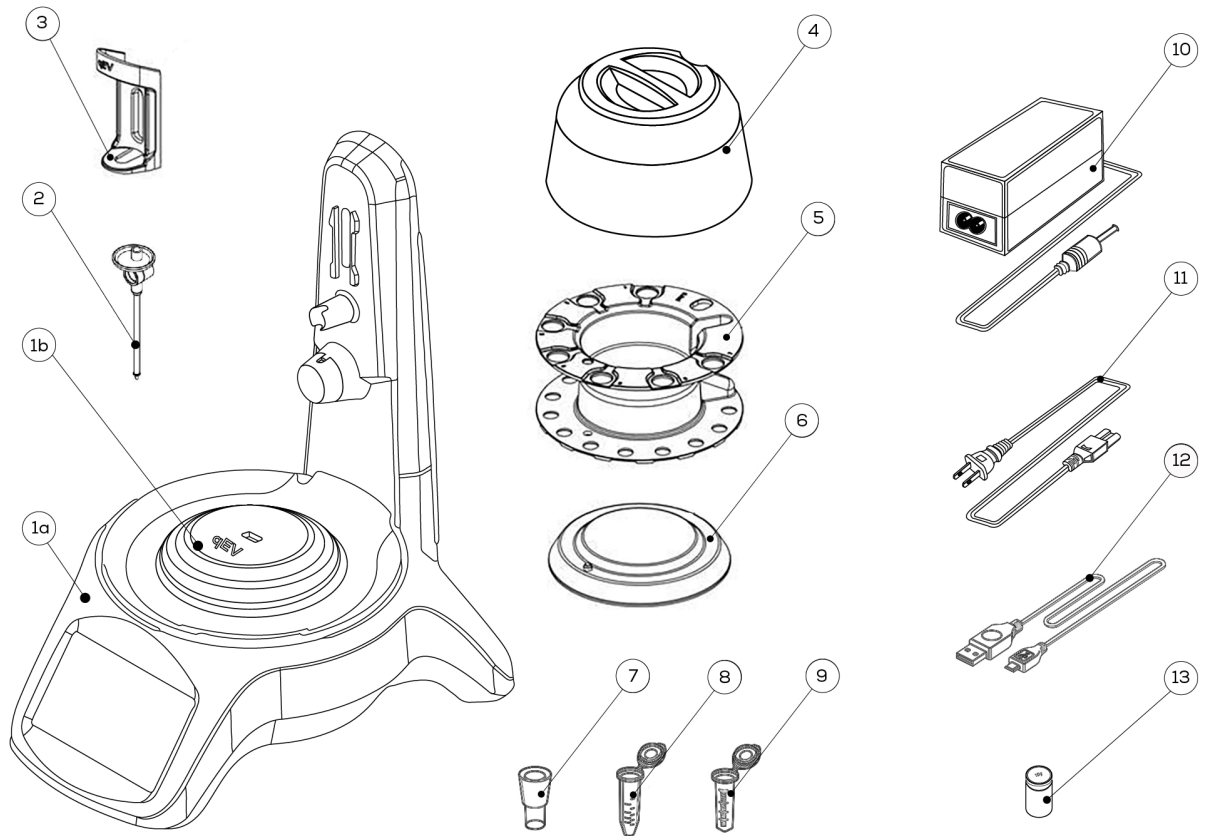

Figure 2: Components of the AFC system.

Layout of the Reversible Carousel

The carousel is reversible and can be used in two orientations; refer to [Section 7.2](#) for information on compatibility with different tube sizes.

The qEV100 is not compatible with the AFC.

[Figure 3](#) and [Figure 4](#) show the layout of the reversible carousel. **Notice that the flush hole does not have a channel for the tube lid.**

In addition to the holes for the collection tubes, both sides of the carousel have the following features:

A	Central Well
B	Central Well Channel
C	Flush Hole

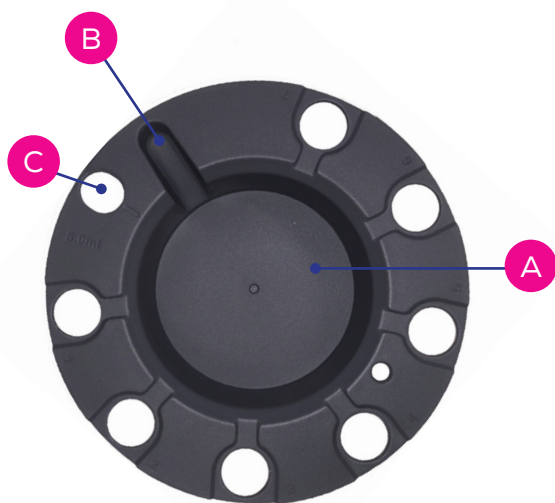

Figure 3: Layout of the carousel with large holes.

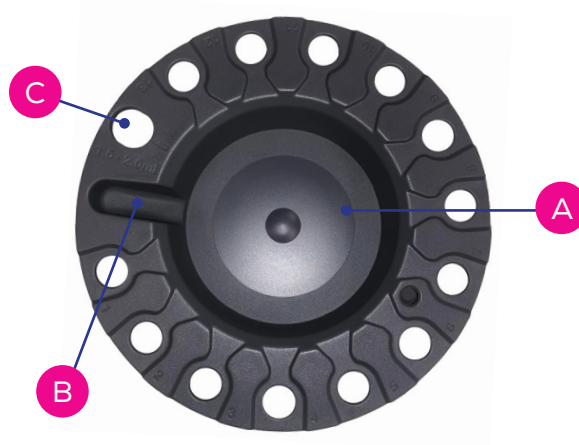

Figure 4: Layout of the carousel with small holes.

- ▶ The following components are required for operation and/or maintenance of the instrument but are not provided:
- ▶ Computer with Windows 10 for updating the AFC operating firmware.
- ▶ A qEV column.
- ▶ Pipettes and tips.
- ▶ Freshly prepared, filtered (0.22 μm) and degassed buffer. Refer to your qEV user manual for more information about buffers.
- ▶ Freshly prepared 0.5 M NaOH solution for column cleaning.
- ▶ 70% ethanol solution for cleaning.

5 / ASSEMBLY AND SETUP INSTRUCTIONS

5.1 Instrument Power and General Operating Procedures

- ▶ Make sure the power supply box is positioned away from fluids.
- ▶ To prevent heat build-up, do not cover the power supply box.
- ▶ Position unit so it can be quickly and easily disconnected from the mains power.
- ▶ Check the local supply meets the AC input requirement given in the specification.



Izon instruments are only to be operated with Izon supplied leads and power supplies. Failure to use the correct power supply may result in invalid operation.



Make sure the power supply is placed away from and to the rear of the instrument to avoid coming into contact with any spills or fluid.

5.2 General Operating Procedures

- ▶ For indoor use only and to be used within the rated conditions noted in system specifications.
- ▶ Take care not to spill any fluids on electrical parts during operation.

5.3 Assembling and Installing the AFC

1. Unpack the AFC and box contents.



We recommend that you save the box and packaging materials in case the instrument needs to be returned for servicing.



If you choose not to save the materials, please recycle them wherever cardboard recycling services are provided.



The AFC has a sensitive weight scale and should not be installed near any equipment that causes vibrations, such as centrifuges, culture and plate shakers, vortex mixers, sonication devices, etc. as this could negatively impact weight measurements.

2. Place the AFC onto a stable and level laboratory bench.
3. Ensure that the clear silicone waste tube of the AFC exits from the rear or side of the instrument and empties into a sink or waste vessel.
4. Connect the power lead to the 12 Volt power supply.
5. Plug the 12 Volt power supply into the rear of the instrument.
6. Plug the power lead into a wall socket.
7. Turn on the instrument using the power switch at the rear. The screen will light up briefly showing the IZON logo and the carousel will rotate to its zero position.
8. Attach the nozzle set to the AFC (Figure 5). For a full demonstration and instructions on how to do this, see 'Installing or Replacing the Nozzle Set' in Section 8.3.



Figure 5: AFC nozzle set correctly in place.

5.4 Aligning the Carousel

After the instrument has been assembled on a level surface, the carousel must be aligned with the fluid nozzle. If the fluid nozzle is already above the flush hole (See Figure 7), then this step may be skipped.

1. Press **Settings** on the left-hand side of the home screen as shown in Figure 6:

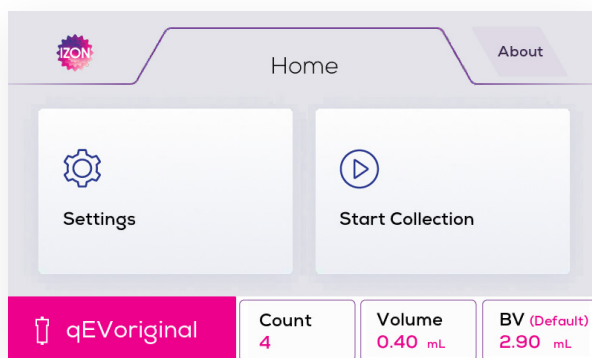

Figure 6: Press Settings on the home screen.

2. Select **Carousel Calibration**.
3. Press the **</>** buttons (for fine alignment) and **<</>>** buttons (for coarse alignment) until the nozzle is positioned directly above the hole in the flush position as shown in Figure 7.



Figure 7: The nozzle tip centred over the flush hole. Note that for the side of the carousel that holds 2 mL tubes, the flush hole will be on the right of the central well channel. For the other side of the carousel that holds 5 mL tubes, the flush hole is on the left of the central well channel.

4. Once the flush hole has been aligned with the nozzle, press **Set Zero**. Press **Back** to return to the home screen.



Improper calibration of the carousel can cause drops from the nozzle to land on the carousel or miss collection tubes. If this occurs, simply recalibrate the carousel. For more information, please refer to the [Troubleshooting Guide](#).

5.5 Calibrating the Scale

The AFC measures the weight of each fraction to determine its volume and ensures uniform volumes across all fractions. Calibration of the scale is performed using the supplied 10 g weight.

Calibration of the Scale

1. From the home screen, press **Settings > Scale Calibration > Start Calibration**, and follow the instructions on the screen.
2. When instructed, remove the carousel and place the carousel cover onto the AFC and press **OK**.
3. The lighting will change to red to indicate that the instrument is measuring the zero weight.



Once the measurement process has started, the user should not bump or interfere with the unit until the lighting has changed back to green to indicate that the process is complete. Any interference will require the user to restart the calibration process.

4. Once the measurement is complete, the lighting will change to yellow and the screen will instruct the user to place the 10 g calibration weight onto the centre of the scale. Remove the carousel cover to place the weight.
5. Replace the carousel cover. **Ensure that the weight is completely still BEFORE** pressing **OK** to continue.
6. The lighting will then change to red to indicate that the instrument is measuring the calibration weight.
7. Once the scale calibration is complete, the lighting will change to green if the calibration was successful, press **OK** to return to the setup menu.
8. Press **Back** to return to the home screen.



The scale should be calibrated before the first use of the AFC, if the unit has been shifted, after every firmware update, or if the AFC is measuring inconsistent fraction volumes during runs. For more information, please refer to the [Troubleshooting Guide](#).

5.6 Adjusting Lighting Settings

The user can choose whether to leave the tower and halo lights on or off through the Setup Menu.

1. From the home screen, press **Settings > Lighting**.
2. On the following screen, select or deselect the tower or halo lighting modules.

6 / qEV SPECIFICATIONS

For column-specific information (including column volume, buffer volume, sample loading volume) see the relevant qEV user manual.

Table 5: qEV Column Specifications (35 nm Gen 2/Legacy, 70 nm Gen 2/Legacy, 20 nm)



COLUMN TYPE	qEVSINGLE (all resin types)	qEVORIGINAL (all resin types)	qEV1 (Gen 2 & 20 nm ONLY)	qEV2 (all resin types)	qEV10 (all resin types)
Reusability	No, single use	Yes, up to 5 times	Yes, up to 5 times	Yes, up to 5 times	Yes, up to 5 times
Buffer reservoir required	No	Yes	Yes	Yes	Yes
Collection tube size	1.5 or 2 mL	1.5, 2 or 5 mL	1.5, 2 or 5 mL	1.5 or 2 mL	5 mL

7 / OPERATING INSTRUCTIONS

7.1 Setting Up a Run

Mounting the qEV Column to the AFC Tower

The AFC comes with a column mount for each compatible column type. Choose the column mount that matches the type of column you would like to use. Once a qEV column and column mount have been attached to the AFC, the column type is detected automatically and is displayed on the AFC touchscreen.



The AFC will only work with RFID-tagged qEV columns. Do not attempt to use un-tagged or non-Izon columns with the AFC instrument.

1. Turn the AFC on by switching on the power button at the rear of the instrument.
2. Check the waste tube to ensure it empties into a sink or waste vessel.
3. Before a column has been inserted or if a column without an RFID tag has been inserted, the lighting will be white, and the home screen will display "No Column" as shown in [Figure 8](#).

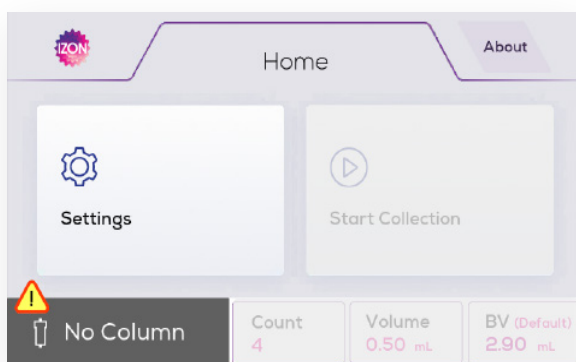

Figure 8: Home screen when no column is attached to the AFC.

4. Fit the appropriate column mount onto the AFC tower.
5. If using a qEV1, qEVoriginal or qEVsingle, remove the top cap prior to removing the lower Luer cap of the column, then proceed to step 6. If using a qEV2 or qEV10, fit the reservoir to the column, remove the lower cap and ensure the fluid is flowing properly before placing the column in the column mount.
6. Insert the column into the column mount, then remove the lower cap and carefully dock the column. Ensure that the Izon logo on the column is facing away from the AFC tower as shown in [Figure 9](#).



Figure 9: A qEVOriginal/35 nm Gen 2 column loaded correctly onto the AFC.

7. Turn the column within the column mount until the type of qEV column used is displayed on the touchscreen as shown in Figure 10.

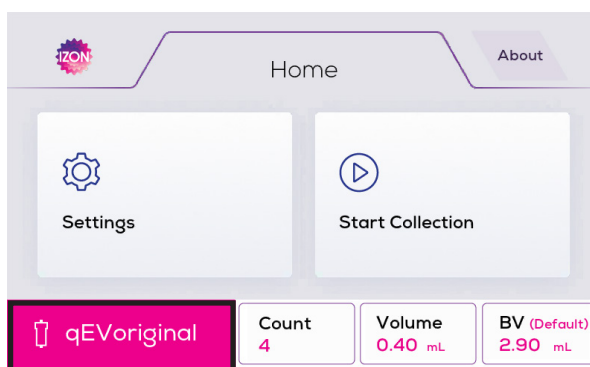

Figure 10: Home screen when a column is attached.



Ensure that the connection between the column and the adaptor is secure to avoid any leakage. It is common for a few drops of buffer to be spilled while connecting the column to the tube adaptor. To minimise this, make the connection quickly and be sure to wipe up any drops that land on the instrument.

7.2 Choosing Run Parameters

Tube Type Selection

The carousel is reversible and can be used in two orientations:

- ▶ One side uses 5 mL collection tubes and has **seven large holes**.
- ▶ One side uses either 1.5 mL or 2.0 mL collection tubes and has **thirteen small holes**. This side cannot be used with the qEV10.

Note: some collection tube brands will not fit properly into the AFC carousel. We recommend ordering 2 mL and 5 mL Axygen tubes (Product codes: MCT-200-C; MCT-500-C, respectively).

The maximum number of fractions that can be collected per run is 30. If you have chosen a fraction count that is larger than the carousel's capacity, the run will pause after the last fraction on the carousel has been filled, and an alarm will sound to indicate it is time to replace the tubes on the carousel.



Be sure that you load the carousel with the collection tube that will hold your required fraction size. For example, if you have chosen a fraction size of 2.0 mL, then 2.0 mL collection tubes must be used.

Fraction Size Selection

If a fraction size greater than 2.0 mL has been selected, the AFC will ask for the 5 mL tube side of the carousel to be loaded, if a fraction size 2.0 mL or less is selected the AFC will ask for the 1.5/2.0 mL tube side of the carousel to be loaded. Options for fraction sizes available for each column are shown in [Table 6](#). The qEV10 always uses the 5 mL tube side of the carousel.

Table 6: Fraction Number, Volume, and Increments for qEV Columns

qEV COLUMN	MAX NUMBER OF FRACTIONS	MIN NUMBER OF FRACTIONS	MAX FRACTIONS IN A SINGLE CAROUSEL	MAX FRACTION VOLUME	MIN FRACTION VOLUME	FRACTION VOLUME INCREMENTS	
qEVsingle						++/--	+/-
Gen 2 (35 nm & 70 nm) and 20 nm	30	1	13	2.0 mL	0.17 mL	0.17 mL	0.05 mL
Legacy (35 nm & 70 nm)	30	1	13	2.0 mL	0.2 mL	0.2 mL	0.05 mL
qEVoriginal							
Gen 2 (35 nm & 70 nm) and 20 nm	30	1	13 or 7*	5.0 mL	0.4 mL	0.4 mL	0.1 mL
Legacy (35 nm & 70 nm)	30	1	13 or 7*	5.0 mL	0.5 mL	0.5 mL	0.1 mL
qEV1							
Gen 2 (35 nm & 70 nm) and 20 nm	30	1	13 or 7*	5.0 mL	0.7 mL	0.7 mL	0.1 mL
qEV2							
Gen 2 (35 nm & 70 nm) and 20 nm	30	1	13	2.0 mL	0.5 mL	0.5 mL	0.1 mL
Legacy (35 nm & 70 nm)	30	1	13	2.0 mL	0.5 mL	0.5 mL	0.1 mL
qEV10							
Gen 2 (35 nm & 70 nm) and 20 nm	30	1	7	5.0 mL	1.0 mL	1.0 mL	0.1 mL
Legacy (35 nm & 70 nm)	30	1	7	5.0 mL	1.0 mL	1.0 mL	0.1 mL

++/-- Large fraction volume increment; +/- small fraction volume increment

*Dependent on orientation of carousel, as qEVoriginal and qEV1 columns are compatible with 1.5 mL, 2.0 mL, and 5.0 mL collection tubes; see [Section 7.2 Choosing Run Parameters](#) for more information.

Buffer Volume Increments

The buffer volume can be changed in increments as shown in Table 7.

Table 7: Buffer Volume Increments and Minimum and Maximum Values

qEV COLUMN	LARGE BV INCREMENT (++)	SMALL BV INCREMENT (+)	MINIMUM BV	MAXIMUM BV
qEVsingle				
Gen 2 / 35 nm	0.17 mL	0.05 mL	0 mL	1.38 mL
Gen 2 / 70 nm	0.17 mL	0.05 mL	0 mL	1.38 mL
20 nm	0.17 mL	0.05 mL	0 mL	1.38 mL
qEVoriginal				
Gen 2 / 35 nm	0.4 mL	0.1 mL	0 mL	4.1 mL
Gen 2 / 70 nm	0.4 mL	0.1 mL	0 mL	4.1 mL
20 nm	0.4 mL	0.1 mL	0 mL	3.7 mL
qEV1				
Gen 2 / 35 nm	0.7 mL	0.1 mL	0 mL	6.8 mL
Gen 2 / 70 nm	0.7 mL	0.1 mL	0 mL	6.8 mL
20 nm	0.7 mL	0.1 mL	0 mL	6.6 mL
qEV2				
Gen 2 / 35 nm	2 mL	0.1 mL	0 mL	23.9 mL
Gen 2 / 70 nm	2 mL	0.1 mL	0 mL	23.2 mL
20 nm	2 mL	0.1 mL	0 mL	22.6 mL
qEV10				
Gen 2 / 35 nm	5 mL	0.1 mL	0 mL	38.2 mL
Gen 2 / 70 nm	5 mL	0.1 mL	0 mL	37.9 mL
20 nm	5 mL	0.1 mL	0 mL	37.4 mL
qEVsingle Legacy				
35 nm	0.2 mL	0.05 mL	0 mL	1.4 mL
70 nm	0.2 mL	0.05 mL	0 mL	1.6 mL
qEVoriginal Legacy				
35 nm	0.5 mL	0.1 mL	0 mL	4.2 mL
70 nm	0.5 mL	0.1 mL	0 mL	4.2 mL
qEV2 Legacy				
35 nm	2 mL	0.1 mL	0 mL	20.1 mL
70 nm	2 mL	0.1 mL	0 mL	20.1 mL
qEV10 Legacy				
35 nm	5 mL	0.1 mL	0 mL	36.4 mL
70 nm	5 mL	0.1 mL	0 mL	36.4 mL

BV: buffer volume

Column Use Counter and Invalid Columns

The AFC instrument records the number of times that each qEV column has been used. The columns are intended to be used **up to five times**.

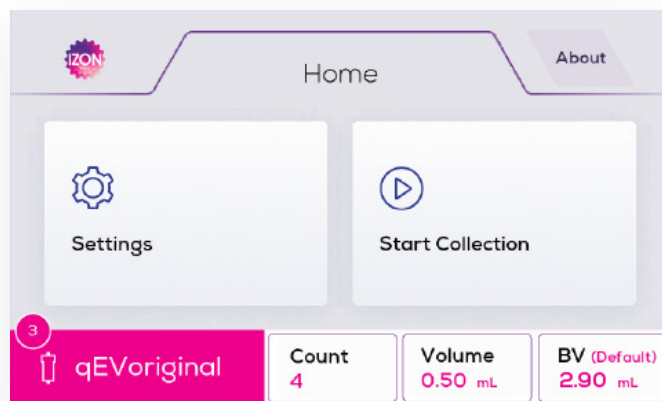

Figure 11: A circle indicator shows how many recommended uses a column has left.



A warning indicator will be displayed when the recommended number of uses (5) has been exceeded, as shown in Figure 12. After 5 uses, the warning indicator will appear and a countdown from 5 to 0 uses will commence. The AFC will display "invalid column" when it has been used a total of 10 times, as shown in Figure 13.

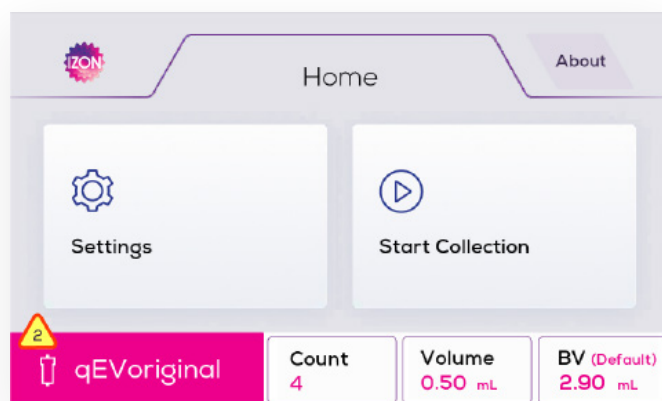

Figure 12: A warning indicator shows how many uses a column has left after the recommended uses have been exceeded.

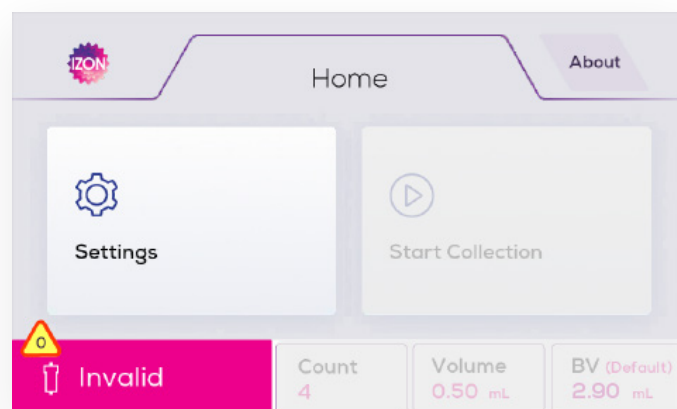

Figure 13: The home screen displaying when a column is invalid.

Adjusting the Collection Schedule and Buffer Volume

Once the appropriate column has been selected and mounted to the AFC tower, the collection schedule must be set.

1. From the home screen, press **Count**, **Volume** or **BV** as shown in Figure 14.

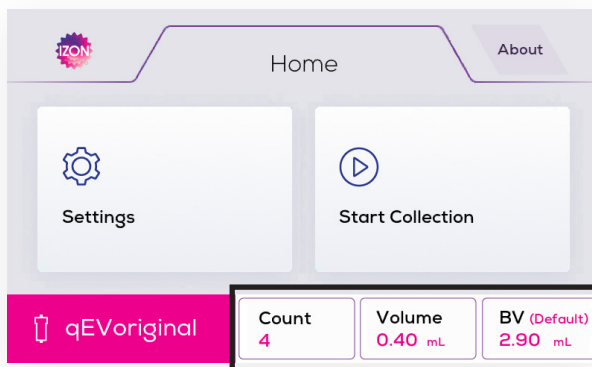

Figure 14: Location of the collection schedule menu.

2. From this screen, you can adjust the fraction number, fraction size and buffer volume size for collection. There are several fraction size options available depending on the column type. Press the **-/+** or **--/++** to choose your collection count, collection size and buffer volume size as shown in Figures 15-17.

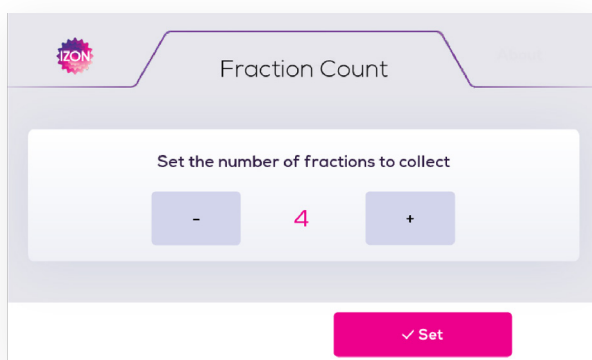

Figure 15: From the Count screen, you can adjust the fraction number. Press **-/+** to choose your collection count. Press **Set** to save your parameters and return to the home screen.

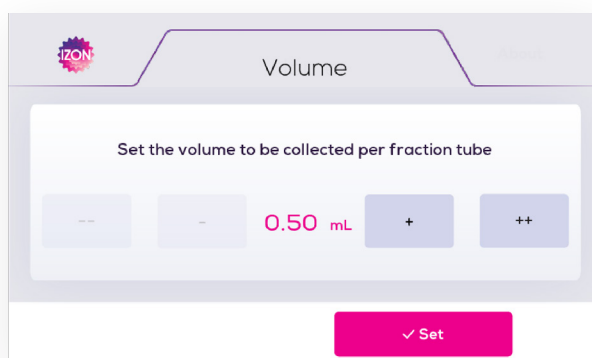

Figure 16: The Volume screen allows you to adjust the volume to be collected per fraction. Press **-/+** to adjust in small increments or **--/++** to adjust in large increments. Press **Set** to save your parameters and return to the home screen.

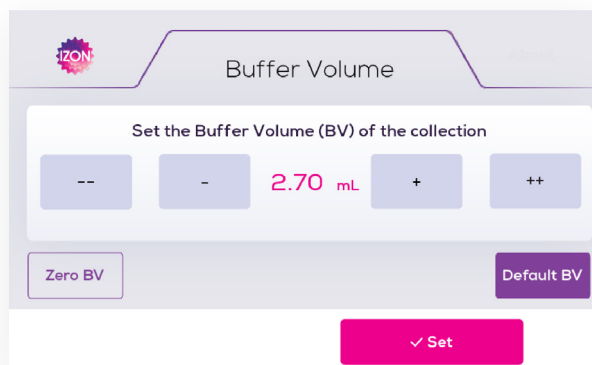

Figure 17: The Buffer Volume menu allows you to set the buffer volume of the collection run. Default BV sets the volume to the recommended buffer volume, while Zero BV sets the buffer volume to zero. Press -/+ to adjust in small increments and --/++ to adjust in large increments. Press Set to save your parameters and return to the home screen.



There is a dead volume inside the nozzle set (nozzle volume) of 0.284 mL. The stated buffer volumes do not include the nozzle volume. To avoid shifting the elution profile, the system automatically adds the nozzle volume to the buffer volume. If the buffer volume is set to zero, this means that 0.284 mL would still be collected in the central well of the carousel.

- When you are ready to start your collection, press **Start Collection** and review your collection parameters.

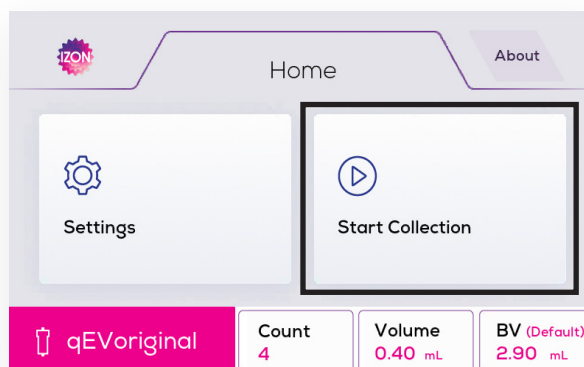

Figure 18: The location of the Start Collection option.

- Press **OK** to proceed to carousel setup or **Back** to return to the home screen.

Setting up the Carousel

Once you have defined your collection parameters, you are ready to prepare the carousel for collection.



Be sure to label collection tubes prior to loading them onto the carousel.

- Load the collection tubes onto the carousel with the lids facing inwards.
- Ensure that you have loaded enough tubes for your collection protocol.
- Gently place the carousel onto the carousel plate. Ensure that the carousel alignment hole engages with the raised carousel alignment pin on the carousel plate as shown in [Figure 19](#).



Figure 19: The alignment pin correctly engaged in the carousel.



Ensure the lids of the tubes are not in contact with the carousel cover, or the scale may not function properly.

7.3 Initiating a Run

Once the carousel has been loaded, the instrument will provide guidance on the column preparation steps before initiating the collection.

Flushing the Column

1. The next screen will ask you to mount the column reservoir. If using a qEVoriginal, qEV1, qEV2, or qEV10 column, mount the reservoir if you have not already fitted it. Figure 20 shows the qEVoriginal column as an example. If using a qEVsingle, a column reservoir is not needed. Press **OK** to continue.



Figure 20: A column reservoir on a qEVoriginal Legacy column.

2. You will now be asked if you wish to flush the column. If this is your first use of the column for the day, **we recommend flushing of all columns with fresh, filtered PBS buffer**. Ensure you have sufficient volume of buffer available; refer to your qEV user manual for column-specific recommendations. Press **Yes** to continue, load the recommended volume of buffer and press **OK** to continue. If you select **NO** the next screen will ask you to load 1 mL of buffer onto the column to prime the nozzle. Press **OK** to continue.
3. If you choose to flush the column, wait for all of the buffer to pass through the column, then press **OK** to continue. If you choose to prime the column, wait for buffer to start dripping from the nozzle, then press **OK** to continue.



While the AFC is in flushing/priming mode, the carousel will be in the flush position and the buffer will flow out of the column and through the flush hole in the carousel, to be pumped out through the waste tube (see Figure 3 and Figure 4). Please check to make sure that the silicone waste tube at the back of the instrument is draining into a sink or suitable waste reservoir close to the instrument.

Sample Loading and Initiating Collection

1. The AFC will ask you to have sufficient buffer available to run the column and to load the sample. Ensure that there is no residual buffer left on the top of the column, remove any excess with a pipette. Now add your sample. Press **Start** to continue.
2. The next screen will prompt the user to place the carousel cover over the AFC if it is not already in place. The cover protects the carousel from being inadvertently bumped during operation.



It is important to only load the sample at this point, let it run through until the flow stops, and then top up the reservoir with the appropriate amount of buffer (displayed on the sample preparation screen). Adding buffer at the same time or before the sample has fully entered the loading frit will dilute the sample and change the elution profile.

3. The column will start running and the carousel will move to the buffer volume collection position. The buffer volume will then begin collecting into the central well of the carousel and the lighting will change to red to indicate that the process has started.
4. When the sample has fully entered the loading frit, top up the reservoir with the correct amount of buffer to resume collection of the buffer volume.
5. When the buffer volume has been collected, the carousel will move to position 1, collect the specified volume and then progressively move to collect each successive individual fraction. If more collection tubes are required than a fully loaded carousel, the lighting will change to yellow and the alarm will sound to let the user know when to remove the cover and load a new carousel or replace the tube positions with fresh tubes and continue the run.

7.4 Completing a Run

After a run has been completed, it is important to clean the column to minimise carryover between samples. The AFC will guide the user through this process via on-screen instructions.

1. When the final fraction has been collected, the display lighting will turn green and the carousel will return to the waste position. The carousel cover and the collection tubes can now be safely removed.
2. If using a qEVsingle, pressing **OK** will return the user to the home screen as these are not reusable, clean the nozzle thoroughly with 70% ethanol solution before continuing. For all other column types the user will be asked if they wish to flush or clean the column.
3. We recommend cleaning the column after every use. Select **Clean** to be guided through the cleaning process. When the cleaning process is complete, the lighting will turn green; press **OK** to return to the home screen. To flush the column without cleaning, select **Flush**.



Remember to empty and clean out the carousel central well between consecutive runs.



The nozzle should be flushed thoroughly with a 70% ethanol solution after the last run of the day to prevent the growth of bacteria within the tubing. Remove the column from the AFC tower during the flushing stage (as the solenoid valve will still be open during the flushing step) and use a Pasteur pipette or Nalgene squeeze bottle to flush the nozzle with 70% ethanol.

AFC Shut Down

1. Before turning off the AFC, rinse the AFC nozzle using DI water with the valve open. This will prevent salt crystallising in the tip of the nozzle while it is not in use.
2. Switch off the AFC at the rear of the instrument.

8 / RESOURCES

8.1 Repair and Servicing of the AFC

- ▶ All replacement parts must be obtained via Izon Science Limited.
- ▶ Contact your regional Izon representative for replacement parts.



We recommend that you save the box and packaging materials in case the instrument needs to be returned for servicing.

8.2 Updating the AFC Firmware

The firmware on the AFC instrument (AFC Operating Firmware) should be updated periodically. If a firmware update is required, an email alert will be sent out to notify the user that an update has been released. It is recommended to check for available updates at least once every six months. There are two firmware modules that are used:

1. **AFC Operating Firmware:** this is the firmware that is used on the AFC instrument; the user interacts with this firmware via the instrument's touchscreen.
2. **AFC Updater:** this is a software package that is used to update the AFC Operating Firmware; it is run on a computer with Windows 10 that is connected to the AFC instrument via a USB cable.

Requirements for Updating the AFC Operating Firmware

1. A computer that is running Windows 10 and is connected to the internet.
2. The USB cable provided with the AFC instrument.
3. The latest version of AFC Updater:
support.izon.com/what-is-the-latest-version-of-the-afc-updater

Downloading and Installing the AFC Updater

The updater can be downloaded onto any computer running Windows 10. Once installed, the AFC Updater will automatically check for the latest version of AFC Operating Firmware that is available.



The computer used to update the AFC Operating Firmware **MUST** be connected to the internet in order to download the latest version of the firmware.

1. Download the AFC Updater using the link shown previously.
2. Install the AFC Updater by following the instructions on your screen.
3. Once installed, the AFC Updater will automatically check to see if the latest version of the AFC Operating Firmware has been downloaded. If an update is available, the Updater will display the release notes for the latest version as shown in Figure 21.
 - a Press **Skip Update** to prevent the download of the updated AFC Operating Firmware.
 - b Press **Get Update** to download the latest version of the AFC Operating Firmware.

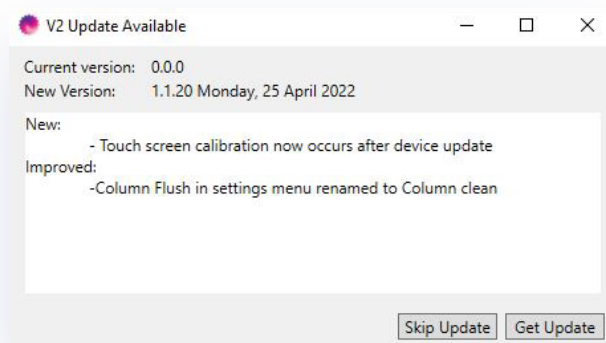

Figure 21: Click **Get Update** to download the latest version of the AFC Operating Firmware.

Updating the AFC Operating Firmware

To update the AFC Operating Firmware, the AFC must be connected to a computer with the AFC Updater installed.

1. Ensure that the AFC Updater is closed.



The updater will only work if the AFC Updater is opened after the AFC has been connected to the computer.

2. Switch the AFC on.
3. Connect the computer to the rear of the AFC instrument using the provided USB cable.
4. Open the AFC Updater.
5. The AFC Updater will automatically check for the latest version of the Operating Firmware. Click **Get Update** to download the latest version.

6. Ensure that Automatic Fraction Collector is shown in the Port box, as shown in Figure 22.

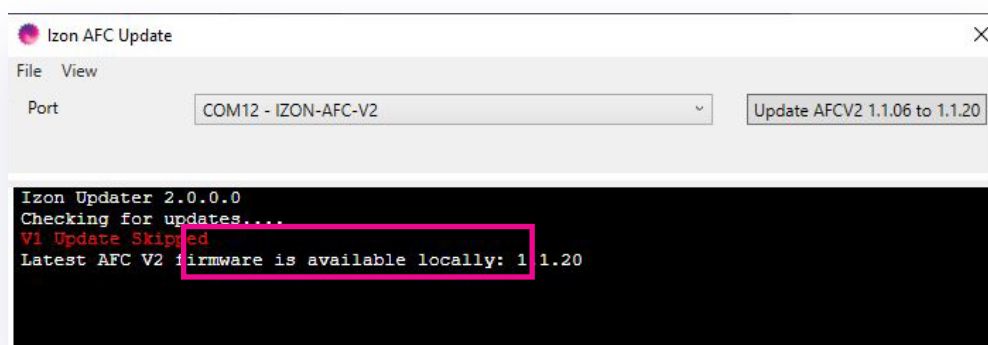

Figure 22: The Izon AFC Updater with the AFC correctly selected in the "Port" dropdown box.



If no device is shown in the Port box, close the software and reopen it.



The precise name (COM port name) of each AFC will not be consistent across computers. It is common for this to change when the AFC is plugged into different computers and occasionally with the same computer. This does not affect the performance of the firmware update.

7. Press **Update AFC** when you are ready to update the Operating Firmware. The update is expected to take up to five minutes.



DO NOT connect or disconnect any USB devices, allow the computer to go into sleep mode or turn off the AFC during the update process as this can interrupt the installation. If the AFC is turned off during the update or the USB is removed, first ensure the AFC is unplugged and turned off, before re-attempting the update process from the beginning. If the problem persists, contact Izon support.

8. During the update, the touchscreen requires calibration. Press the three blue dots then the orange dot on screen in the order they appear with the back of a pen or pencil to calibrate the screen.
9. Once the firmware update is complete, disconnect the USB cable and close the AFC Updater.

8.3 Maintenance of the AFC

Scale Care and Calibration: Best Practices

The AFC contains a sensitive scale for measuring buffer volume and fraction volume. To ensure the accuracy of this scale, the following guidelines have been established as best practices for care and calibration of the AFC scale during transport and use. The scale calibration can be accessed from the **Settings** menu, provided a collection run is not taking place. Best practices:

- ▶ It is recommended that the AFC goes through a scale calibration before the first use of each day.
- ▶ Transport: refer to instructions on page 8.
- ▶ If you move the AFC (e.g., lifting and replacing it on the same spot on a bench), calibrate the scale before use.
- ▶ During operation, avoid exerting any unnecessary force onto the scale, including through the carousel plate and carousel.
- ▶ Only load the following items onto the scale, to prevent overloading: carousel plate, carousel, fraction tubes, 10 g weight.

Surface Decontamination

The following areas can be cleaned with 70% ethanol and a non-abrasive cloth or towel:

- ▶ Outer plastic shell of the AFC instrument
- ▶ The reversible carousel
- ▶ Carousel cover
- ▶ Column mount
- ▶ Carousel plate
- ▶ The touchscreen display should be cleaned with a gentle cloth and 70% ethanol.



To prevent electrical shock, always turn off and unplug the instrument prior to performing decontamination procedures.



Do not use abrasive or corrosive detergents or strong alkaline solutions. These agents can damage the plastic and metal components of the instrument.

Installing or Replacing the Nozzle Set

Installing the Nozzle Set for the first time, or looking for a refresher? Visit support.izon.com/how-to-install-the-afc-nozzle-set for a full demonstration. Steps for removing and replacing the nozzle set are summarised below:

1. Open the **Settings** menu and navigate to the fluid tab, then toggle the valve open.
2. Remove the pinch valve cover by firmly grasping the pinch valve cover and gently pulling away from the AFC tower.



Figure 23: Pinch valve cover on.



Figure 24: Pinch valve cover removed; pull tube laterally.

3. Firmly grasp the nozzle tube above and below the pinch valve and gently pull away (laterally) until the nozzle tube is free.

A new nozzle is inserted back into the pinch valve in the same manner:

4. Firmly grasp each end of the new tube and gently slide it into the pinch valve.
5. Using your fingertip, gently press the tube into the pinch valve. Ensure that the entirety of the tubing is within the pinch valve channel as shown in [Figure 25](#). The tubing should not bow away from the channel as in [Figure 26](#). Be sure to press the tube into the pinching mechanism, located within the channel.



Figure 25: Nozzle tube fully inside the pinch valve.



Figure 26: Part of the nozzle tube outside of the pinch valve.

6. Ensure that the tip of the nozzle tube is free from the pinch valve and that the neck of the nozzle tip is protruding from the channel as shown in [Figure 27](#).



Figure 27: Nozzle tip free from the pinch valve.

7. Put the pinch valve cover back onto the instrument. The nozzle tip should fully emerge from the hole in the pinch valve cover and be visible once the cover has been replaced, as shown in [Figure 28](#).

If the tip is hidden behind the pinch valve cover, then the tube has been inserted too high in the pinch valve. Simply grasp the nozzle tip and pull gently down (distally) to move the tube further down in the pinch valve channel.

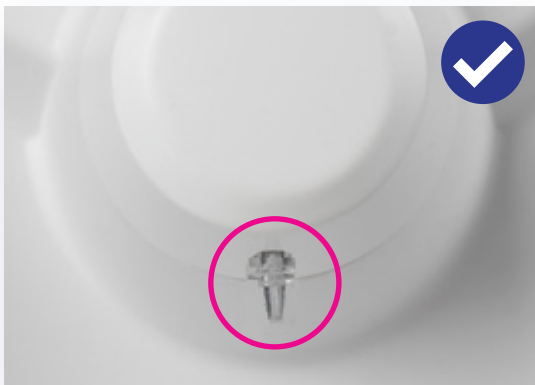

Figure 28: Nozzle tip fully emerging through the hole in the pinch valve cover.

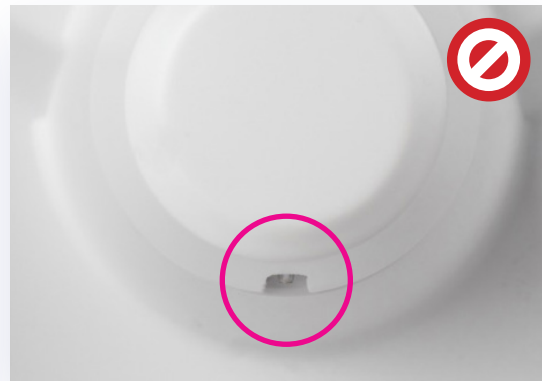

Figure 29: Nozzle tip hidden behind the pinch valve cover.

8.4 Troubleshooting

Table 8: Troubleshooting Common AFC Faults

OBSERVATION	FAULT	RESOLUTION
Device does not turn on If the unit flashes when turned on, but does not work	Faulty power source or power lead. Power connector is not fully plugged in. Internal connections have loosened during transit.	Check the device is switched on and plugged in correctly. If there is still no power, try an alternative power source. Contact Izon support. Please provide the serial number (underneath the unit).
Leakage from the column outlet-to-tube adaptor connection	Column is not connected securely to the nozzle. Nozzle is damaged.	Check the column is fully pushed into the top of the tube adaptor. Check the nozzle is not damaged (look for a crack around the join), replacement parts can be found in the consumables box.
Leakage from the tube adaptor-to-tubing connection	Tubing is not fully pushed into the nozzle. Tubing is damaged.	Check the tube adaptor is securely connected into the tubing. Check the tubing is fully pushed into the nozzle. Remove the valve cover and inspect the tubing, replacement parts can be found in the consumables box.
Dripping from the nozzle when the valve is closed	Tubing is not fitted in the valve correctly. Valve is not working correctly.	Remove the valve cover and ensure the tubing is fitted in the channel of the pinch valve head properly. If there is no clicking noise when the valve is toggled in the Settings menu, this indicates a faulty valve. Contact Izon support.
Tower or halo lights are not working	Lights are turned off in the setup menu under Lighting . LEDs are faulty or damaged.	Make sure the lights are on in the setup menu under Lighting if required. Contact Izon support.
The touchscreen is delivering wrong outputs	Two areas are touched simultaneously. Screen is touched too quickly and/or too hard.	Make sure the desired area on the screen is touched centrally and firmly. Use a pen/stylus to trigger a smaller area. Do not touch the screen repetitively before a response is acknowledged.
Loud motor noise/ crunching noise	Gear belt too loose or obstructed.	Contact Izon support.
Fractions are skipped	Fraction change is triggered by vibrations or something touching the carousel while the collection is in progress. Damaged Scale.	Place the device on a stable surface with minimal disturbances from other devices. Ensure that the carousel cover is used, and the device is not bumped or touched during operation.

OBSERVATION	FAULT	RESOLUTION
Incorrect fraction volumes and/or number of fractions, overflow of fractions	<p>Fraction volumes and numbers are set incorrectly in the collection schedule.</p> <p>Device is not on a stable surface.</p> <p>Scale calibration is incorrect.</p> <p>Collection tube lids are touching the carousel cover.</p> <p>Damaged scale.</p>	<p>Check the fraction volumes and numbers are correct in the collection schedule setup.</p> <p>Make sure the device is placed on a stable surface with minimal disturbances from other devices.</p> <p>Run a Scale Calibration under the Settings menu.</p> <p>Ensure the collection tube lids are not touching the carousel cover. Note, this is more likely to occur on the carousel side with the large holes.</p>
Droplets are catching on the valve cover	<p>Nozzle is pushed back too far inside the valve.</p> <p>Valve cover is too loose.</p>	<p>Check the nozzle is placed inside the channel of the valve head but not fully pushed in, the user should be able to see the nozzle tip outside of the valve cover.</p> <p>Ensure the valve cover is fitted firmly over the valve head.</p>
Droplets are catching on the carousel during the flushing procedure	<p>Carousel is not aligned correctly.</p> <p>Nozzle is bent.</p>	<p>Recalibrate the carousel alignment to the centre of the flush position and make sure to press Set Zero.</p> <p>Reposition the nozzle to a vertical position or replace. Replacements can be found in the consumables box, or at store.izon.com.</p>
Spillage of liquid onto the table or overflow onto the area surrounding the carousel plate during the flushing procedure	<p>Waste tubing to the pump is not connected or faulty.</p> <p>Waste tubes or flush hole are obstructed.</p> <p>Pump is faulty.</p> <p>Waste tube not in waste container.</p>	<p>Make sure the waste tubes on the bottom of the device are connected and free of any obstruction. Ensure that the flush hole is not obstructed.</p> <p>If the pump is silent during the flushing steps, contact Izon support.</p> <p>Ensure that the free end of the tubing is in a waste container.</p>
Vibration detected	<p>Unstable surroundings.</p> <p>Nozzle set incorrectly fitted or due to be replaced.</p>	<p>Visit support.izon.com/how-do-i-troubleshoot-vibration-detection-on-the-afc-v2</p>

OBSERVATION	FAULT	RESOLUTION
Column will not flow (during flushing or elution steps)	<p>If using qEV2 or qEV10, a bubble can become trapped in between the top Luer connection and reservoir, impeding the fluid flow.</p> <p>If using a qEVoriginal, qEV1 or qEVsingle, air trapped below the white frits or in the nozzle tube may be impeding the flow.</p>	<p>Ensure the reservoir is filled with buffer and flowing properly before connecting to the column.</p> <p>Replace the column. Do not leave the columns without buffer on the top frit for long periods of time. Always remove the top cap first, while the lower cap is still on.</p> <p>Contact Izon support.</p>
AFC flush hole will not drain	<p>If no sound can be heard during the flushing step, the pump will be faulty.</p>	<p>Contact Izon support.</p>

CONTACT US

Additional support material is available at support.izon.com

If you have any questions that are not answered on the support portal, or your instrument requires repairs/maintenance please contact our support staff via the online support portal by raising a support ticket. When reporting AFC issues to Izon support, please provide the serial number of the AFC, which can be found on the underside of the AFC as in [Figure 30](#). Please also provide the AFC firmware version which can be found on the About screen as in [Figure 31](#) by pressing **About** in the top right of the home screen.

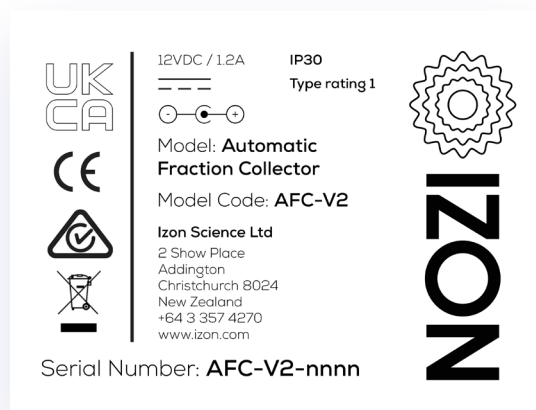

Figure 30: The AFC serial number and compliance sticker.

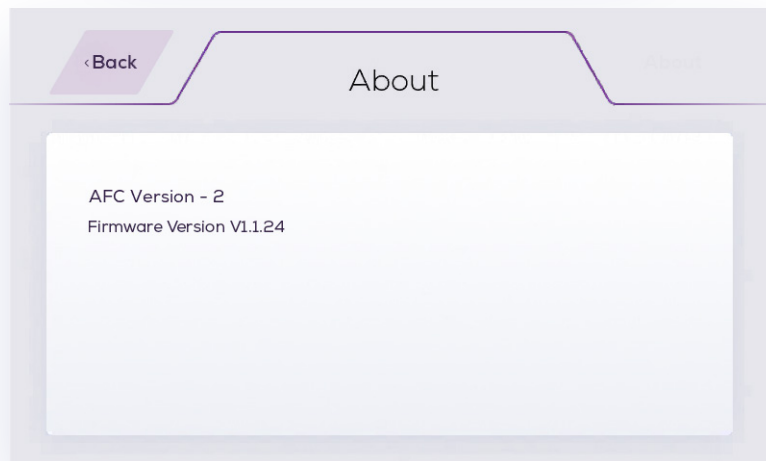

Figure 31: The AFC About screen displaying the current firmware version.

FCC Declaration of Conformance:

This device complies with part 15 of the FCC Rules. Operation is subject to the following two conditions:

- (1) This device may not cause harmful interference
- (2) This device must not accept any interference received, including interference that may cause undesired operation. Changes or modification not expressly approved by the party responsible for compliance could void the user's authority to operate the equipment.

